

Jambs

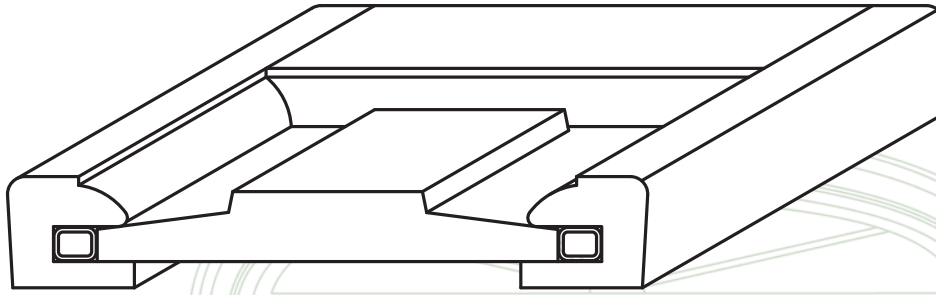

Raised Panel Jamb
POP

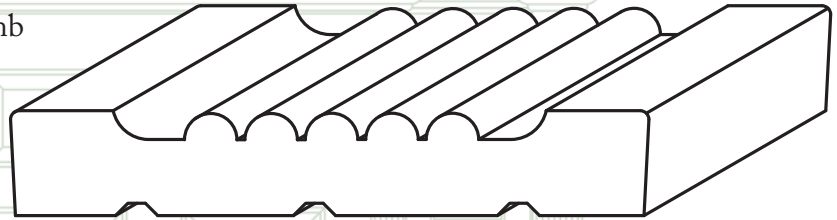

Reeded Jamb
OAK, POP, RFJ

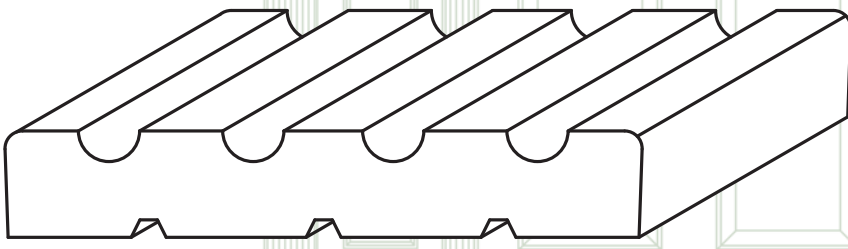

Fluted Jamb
OAK, POP, RFJ

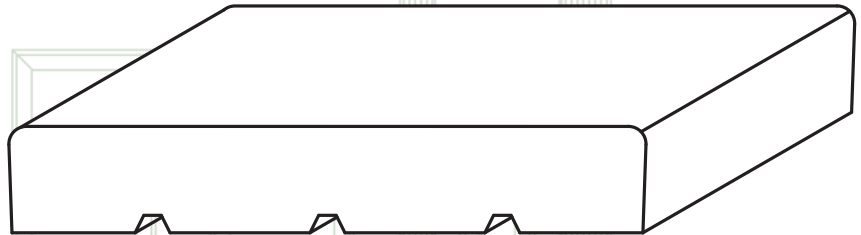

Flat Jamb
CHE, MAP, OAK, POP, PFJ, RFJ

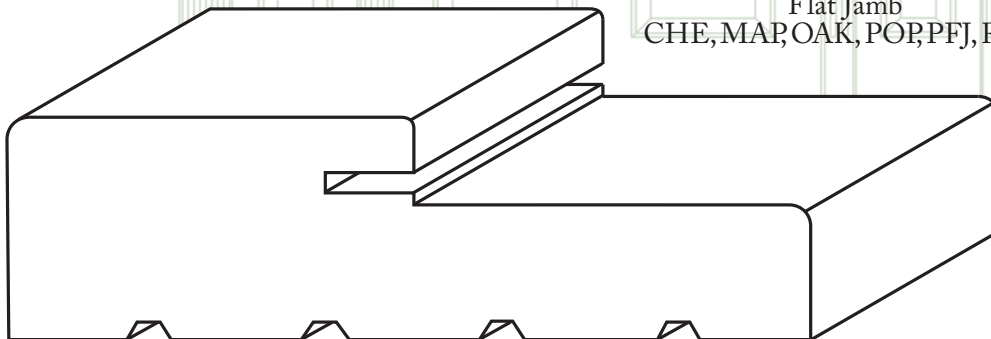

Exterior Rabbeted Jamb
CHE, FIR, MAH, OAK, POP, PFJ, WP

Astragals

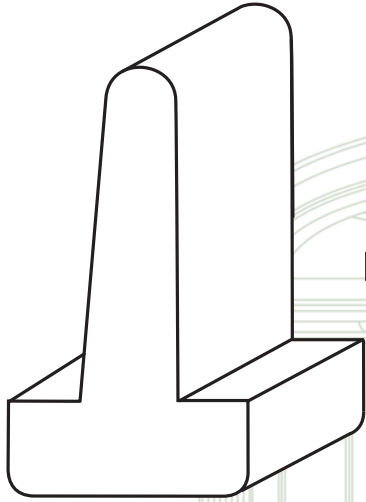

T-AST Interior
1 ¼" x 2 ¼"
CHE, MAH, OAK, POP, WP

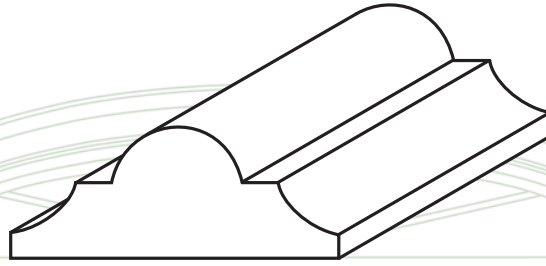

133 Flat Astragal
1 ¼" x 1 ¾"
WP

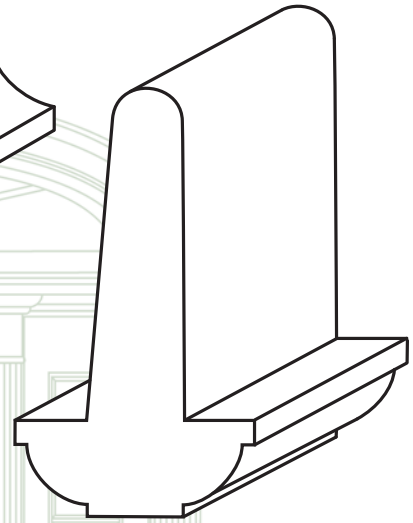

T-AST Interior
1 ¼" x 2 ¼"
OAK, WP

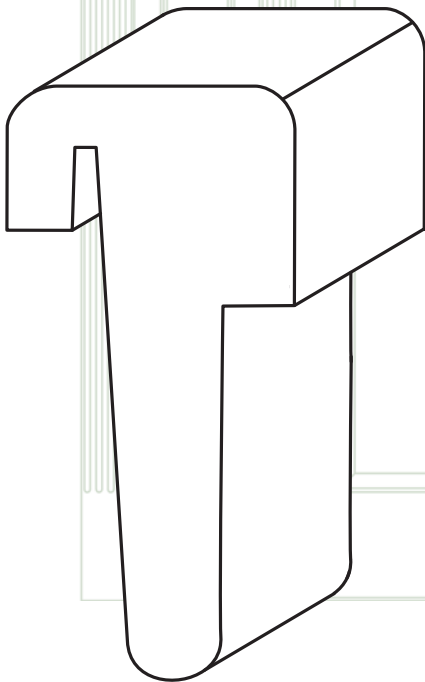

T-AST Exterior
1 ½" x 3 ⅛"
MAH, OAK, POP, WP

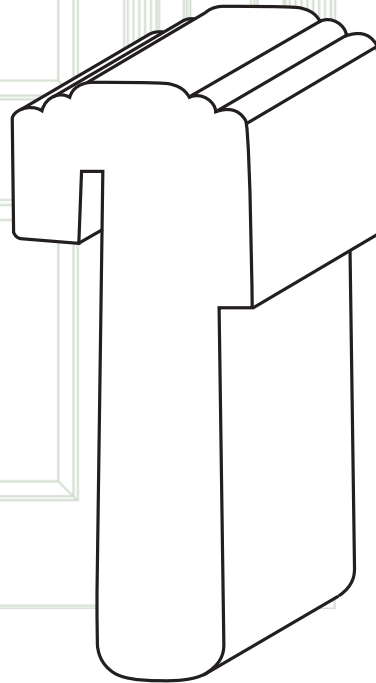

T-AST Exterior
1 ½" x 3 ⅛"
OAK, WP