

## Panel and Picture Moulds

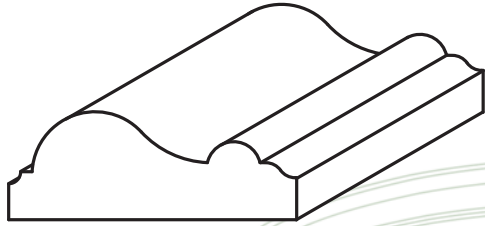

216  
 $\frac{1}{16}$ " x 1  $\frac{1}{2}$ "  
 OAK, PFJ, WP

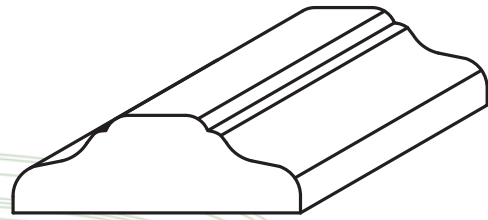

1648  
 $\frac{1}{2}$ " x 1  $\frac{1}{2}$ "  
 CHE, OAK, POP

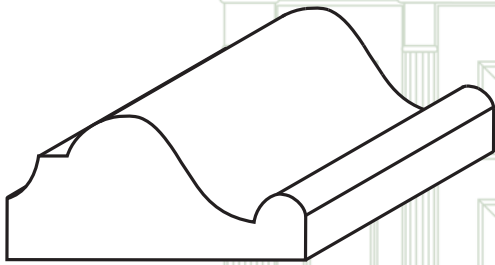

200-PM  
 $\frac{3}{4}$ " x 1  $\frac{1}{16}$ "  
 OAK, POP

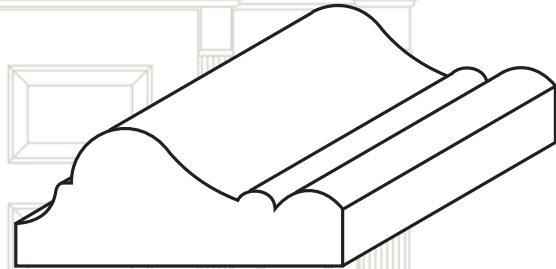

2048-KW-PM  
 $\frac{5}{8}$ " x 1  $\frac{1}{2}$ "  
 POP

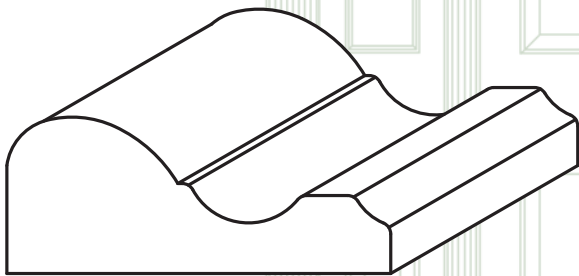

2664-P  
 $1\frac{3}{16}$ " x 2"  
 CHE, OAK, POP

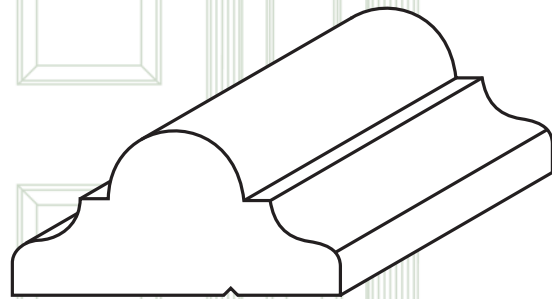

2448-BM  
 $\frac{3}{4}$ " x 1  $\frac{1}{2}$ "  
 POP, RFJ

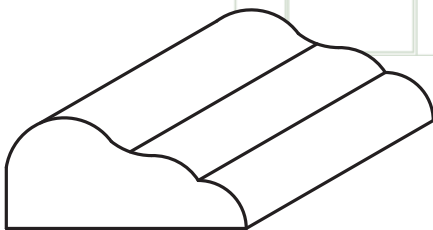

1840  
 $\frac{1}{16}$ " x 1  $\frac{1}{4}$ "  
 CHE, OAK, POP

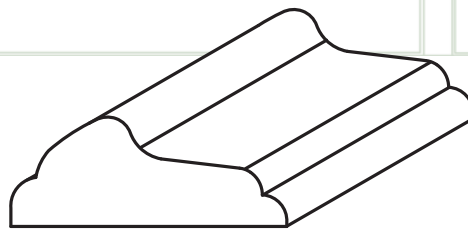

1846  
 $\frac{1}{16}$ " x 1  $\frac{7}{16}$ "  
 CHE, OAK, POP, RFJ

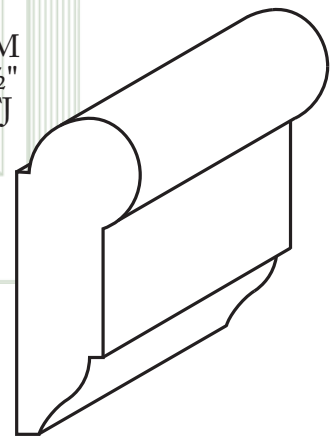

8263  
 $\frac{5}{8}$ " x 1  $\frac{3}{4}$ "  
 OAK, WP

## Notched Panel Moulds

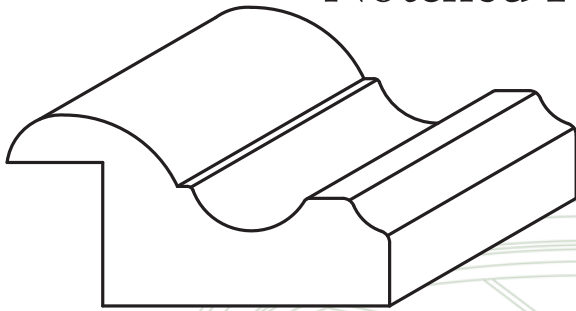

3264-PR  
1" x 2"  
CHE, OAK, POP, RFJ

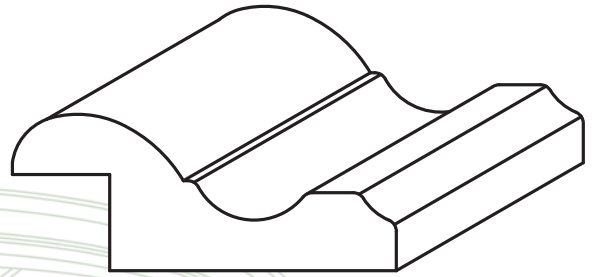

2664-PR  
1<sup>3</sup>/<sub>16</sub>" x 2"  
CHE, OAK, POP

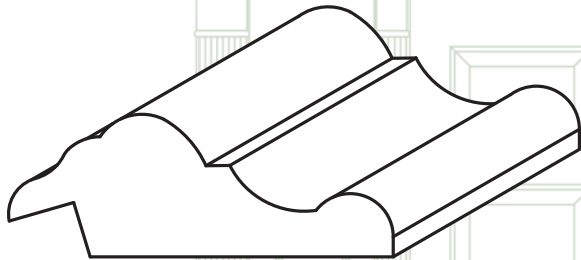

2464-PM  
3/4" x 2"  
CHE, OAK, POP  
Can be positioned  
to accomodate a  
thickness of 3/16" to 3/4"

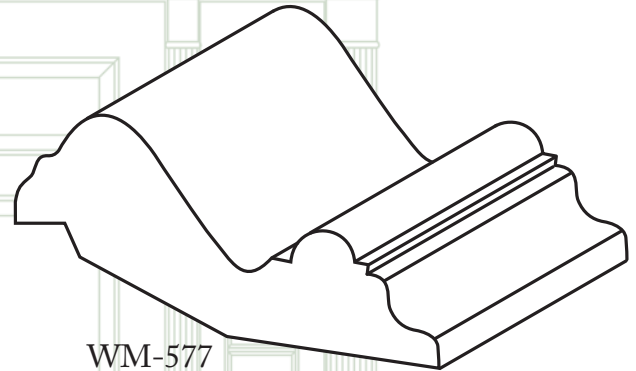

WM-577  
3/4" x 2 3/8"  
POP

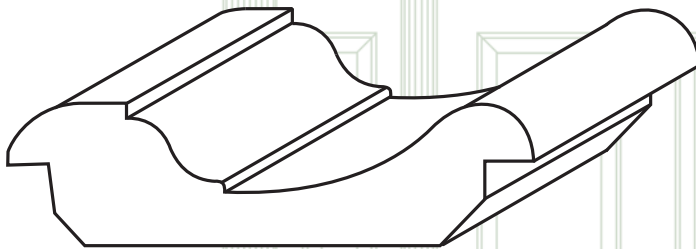

2488-KW-PR  
3/4" x 2 3/4"  
POP

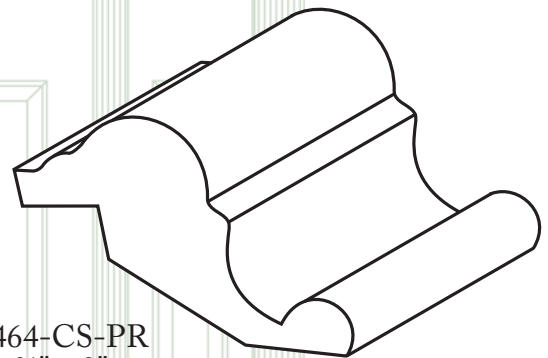

2464-CS-PR  
3/4" x 2"  
OAK, POP

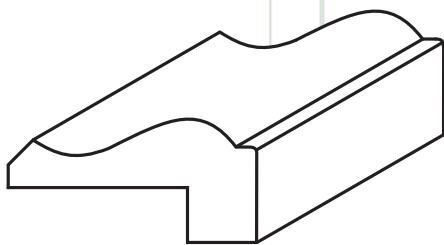

WM-292  
9/16" x 1 1/8"  
OAK, WP

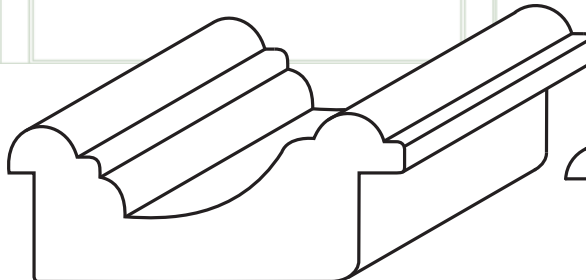

2866-PM  
7/8" x 2 1/16"  
POP

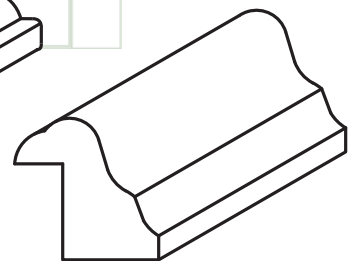

2424-R  
3/4" x 3/4"  
CHE, OAK, POP